

The image features a background of a blurred outdoor scene with people sitting on a deck. A large, dark blue, textured vertical panel is on the right side. The Millboard logo is in the top left corner, and the title 'The Millboard Collection' is in the lower left.

millboard

Live. Life. Outside.

—
The Millboard
Collection

A close-up, high-angle photograph of a wooden deck. The deck is made of wide, light-colored wooden planks with a prominent grain. In the upper right, a portion of a chair is visible, featuring a dark, woven seat and light-colored wooden legs. In the lower right, a dark cup sits on a circular wooden coaster. The scene is lit with bright, natural light, casting soft shadows.

Your dream deck
awaits...

millboard



Contents

| | | |
|------------------------|------------------------------------|----|
| About Millboard | The Millboard story | 4 |
| | A closer look | 6 |
| | Why choose Millboard decking? | 7 |
| Enhanced Grain | The Collection | 8 |
| | Case Studies | 26 |
| Weathered Oak | The Collection | 34 |
| | Case Studies | 42 |
| Lasta-Grip | The Collection | 48 |
| Edging & Fascia | The Collection | 52 |
| | Colour options | 55 |
| DuoSpan & DuoLift | The Collection | 56 |
| | About DuoSpan and DuoLift | 58 |
| Components & Materials | The Collection | 66 |
| | Plas-Pro | 68 |
| | Touch-up Coating | 70 |
| | Durafix® | 71 |
| Useful Information | Working specification | 72 |
| | A focus on sustainability | 74 |
| | Maintenance | 75 |
| | Alternative Uses | 76 |
| | Envello® Cladding | 78 |
| | Samples, Ordering and Installation | 82 |



The Millboard story

Enduring beauty

A family-run business, the company has been marrying British craftsmanship to the inspiration of nature since 1976. Millboard decking demonstrates the company's commitment to quality and visual distinction.

1976

Millboard founding family starts Stonemarket, which revolutionises cast paving – later sold to a large group entity.

1998

After the sale of Stonemarket, attention turns to production of stone-look planters and other innovative outdoor products.

2007

After four years of ground-breaking development, Millboard wood-look moulded decking is launched to the UK market.

2014

Millboard is voted one of the top 1000 companies in the UK to inspire Britain – a major achievement in just seven years.

The only decking hand-moulded from natural timbers, Millboard decking is virtually indistinguishable from real wood, yet outperforms it on almost every level. Unlike timber, Millboard decking resists the elements, requires minimal maintenance, is slip and stain resistant and won't rot from fungal decay or warp.

The mould masters for the Millboard range are carefully selected. The Weathered Oak range, for example, is moulded from over a century old oak boards. And the Enhanced Grain range is exquisitely rendered from refined timber for a smoother look and feel.

Each board is carefully hand-coloured in the realistic true-to-life tonal shades that are Millboard's signature feature. This attention to detail reflects Millboard's desire to provide the most authentic wood-look decking on the market today.

Our ethos is to continually reinvest in new product research and development. This has led us to bring some of the most advanced and unique products to the market - our patented Durafix® screws and Lastane® coated board are just two of our exclusive innovations.

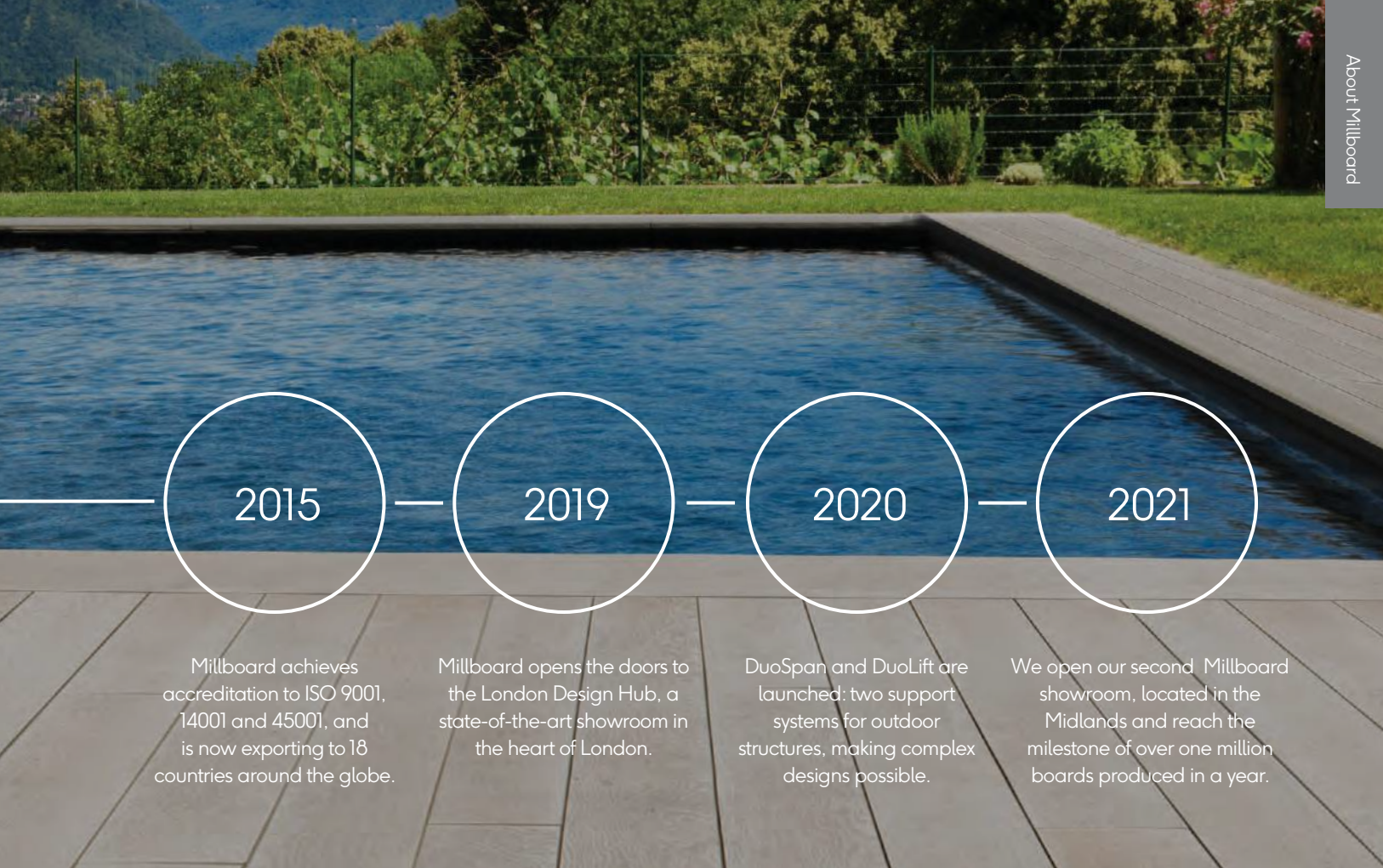

2015

Millboard achieves accreditation to ISO 9001, 14001 and 45001, and is now exporting to 18 countries around the globe.

2019

Millboard opens the doors to the London Design Hub, a state-of-the-art showroom in the heart of London.

2020

DuoSpan and DuoLift are launched: two support systems for outdoor structures, making complex designs possible.

2021

We open our second Millboard showroom, located in the Midlands and reach the milestone of over one million boards produced in a year.



About Millboard decking



A closer look

Millboard decking uses a unique material, unrivalled across the globe. Take a closer look at the construction and performance of this stunning yet functional decking.



Tough

The unique Lastane® layer is more resistant to scratches and stains and is designed to better withstand demanding outdoor environments.

Enduring

The dual-tone Lastane® surface is hand tinted using pigments designed to improve resistance to sun damage and fading.

Safer

Millboard decking is wood-free and non-porous which, in comparison to timber, means good resistance to algae growth and excellent slip resistant properties.

Beautiful

Each length is hand moulded using specially selected timber masters for an unrivalled organic wood-grain appearance in a composite material.

Durable

Millboard will not split, rot or harbour insects like timber does.

Stronger

The structural core is a blend of natural minerals bonded in a polymer resin with renewable biopolymers and fibre reinforcement for added strength and durability.

Lighter

Our unique closed 'cellular' internal structure reduces weight while maintaining strength.

Millboard decking provides the aesthetic and natural beauty of real wood, without the associated shortcomings. The polyurethane core provides structural durability and strength and eliminates the risk of rotting, warping and core material deterioration.

The resin core is reinforced with fibre for additional strength, stability and reassurance and features renewable biopolymers. The Lastane® surface is pliable and provides high slip-resistance compared to timber, even in wet conditions.

Crafted to be perfectly imperfect

Each length of Millboard deck is the result of a long process of craftsmanship and attention to visual detail. Just like the specially selected Oak timbers used to create the unique moulds, the fine details and natural imperfections in the original material has to be recreated in the super durable millboard product.

From the initial laying of the Lastane surface, right through to the pouring of the fibre-reinforced resin mineral, we focus on achieving the quality of finish, reflecting the true random and natural characteristics of the original timber. Our mission is to accurately reproduce the original whilst adding all the benefits of our unique board technology, this is why many of our processes are carried out manually. For example, each piece is hand coloured to establish the authentic wood finish our boards are renowned for.

We have great respect for the skilled eye of an artist and are therefore committed to the hand colouring system. The resulting true-to-life shades speak for themselves.

Every step of your decking's journey is characterised by Millboard's artisan methods.



Why choose Millboard decking?



More resistant to algae

Unlike wood, there is no protein content to assist algal growth within the boards.



Slip-resistant

In testing, millboard has a lower slip potential than timber, especially in the wet.



Mould masters from real oak

Not extruded like most composites. Millboard decking looks just like the real thing.



Environmentally friendly

Base materials have low impact on global warming and ozone depletion.



Lightweight

Easier to handle and install.



Splinter free surface

No wood content means absolutely no splinters on the surface.



Non-porous

It's non porous surface makes it easier to clean small spills.



Low maintenance

Does not require regular sanding, staining or oiling, simply clean the boards twice a year.



Does not warp or rot like wood

No timber content that will rot or be eaten by insects and pests.



UV and weathering stability

UV stabilised for better performance over time.



'Lost head' fixing

Durafix® fixings are virtually hidden beneath the unique Lastane® surface.



Low carbon footprint

Independently and UKAS accredited to the ISO 14064-1 Verified Carbon Footprint Assurance Mark.



The Collection:

Enhanced Grain

Exquisitely replicating every detail you'd expect from real wood



Smooth, sleek texture

Moulded from timbers that are selected from oak boards for a textured look and feel, the Enhanced Grain collection's contemporary design accurately recreates the subtle nuances of natural wood. Each of the shades are slip-resistant and showcase their organic patinas beautifully.

176 x 3600 x 32mm (Approximate sizes)
1.54 boards per m²



Enhanced Grain

Antique Oak

Antique Oak's natural, warm hues are similar to the tones of tropical hardwood and the appearance is reminiscent of attractively aged flooring.

Antique Oak boasts more tonal variation per individual board than any of the other colours in the Millboard range, providing a beautiful and organic look.

| | |
|--------------|--------------------------------|
| Board size | 176 x 3600 x 32mm |
| Coverage | 1.54 boards per m ² |
| Product code | MDE176A |



Subframe
See page 58



Alternative uses
See page 78



Product samples
See page 82



Discover more about Antique Oak:
millboard.co.uk/antique-oak

Find an Approved Installer or Premier Distributor:
millboard.co.uk/locator



Enhanced Grain Smoked Oak

A cool, elegant grey, ideal for contemporary and coastal settings. Smoked Oak has a soft-grey hue and browner tones that nod to time-seasoned hardwoods – yours to enjoy without the wait.

Its silvery decadence is at once contemporary and traditional. Smoked Oak tastefully distinguishes any outdoor space.

| | |
|--------------|--------------------------------|
| Board size | 176 x 3600 x 32mm |
| Coverage | 1.54 boards per m ² |
| Product code | MDE176D |



Subframe
See page 58



Alternative uses
See page 78



Product samples
See page 82



Discover more about Smoked Oak:
millboard.co.uk/smoked-oak

Find an Approved Installer or Premier Distributor:
millboard.co.uk/locator

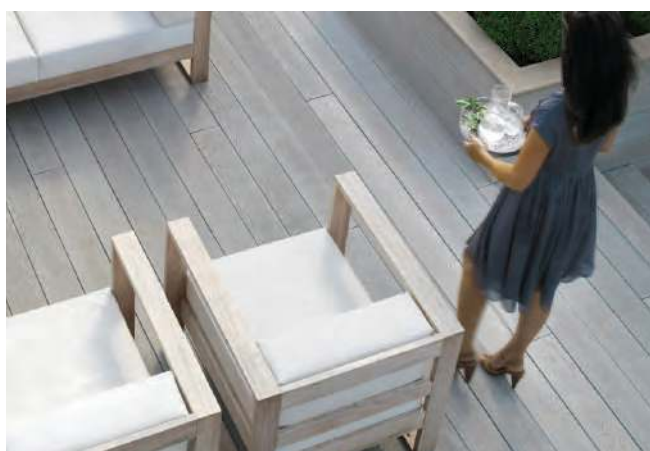

Enhanced Grain

Brushed Basalt

Brushed Basalt is the most authentic painted-wood-look decking board available, perfect for seamless transitions between indoor and outdoor spaces.

Consciously styled to harmonise with interiors, Brushed Basalt's glamorous blue-grey hues are hypnotic and interplay beautifully with other cool and contemporary tones.

| | |
|--------------|--------------------------------|
| Board size | 176 x 3600 x 32mm |
| Coverage | 1.54 boards per m ² |
| Product code | MDE176B |



Subframe
See page 58



Alternative uses
See page 78



Product samples
See page 82



Discover more about Brushed Basalt:
millboard.co.uk/brushed-basalt

Find an Approved Installer or Premier Distributor:
millboard.co.uk/locator



"We opted for Brushed Basalt as it has such a contemporary feel, fostering harmony between our house and the garden. The grain looked so realistic, we couldn't believe it was a replica of timber!"

Mr and Mrs Hylton Homeowners



Enhanced Grain Limed Oak

The look of beautifully sun-drenched timber. Limed Oak has a pale, washed appearance which is the perfect complement to outdoor spaces in sunnier climes.

Limed Oak provides a clean and dreamy aesthetic. Its cool and sophisticated presence allows you to create a refined terrace arrangement, whatever the brief.

| | |
|--------------|--------------------------------|
| Board size | 176 x 3600 x 32mm |
| Coverage | 1.54 boards per m ² |
| Product code | MDE176L |



Subframe
See page 58



Alternative uses
See page 78



Product samples
See page 82



Discover more about Limed Oak:
millboard.co.uk/limed-oak

Find an Approved Installer or Premier Distributor:
millboard.co.uk/locator



Enhanced Grain Burnt Cedar

A dramatic statement in smooth black/brown, inspired by the Japanese Yakisugi technique of burning timber to preserve it. Burnt Cedar is the perfect mix of modern and traditional styles.

With warm undertones, Burnt Cedar is a bold showstopper and demonstrates both elegance and decadence in equal measure.

| | |
|--------------|--------------------------------|
| Board size | 176 x 3600 x 32mm |
| Coverage | 1.54 boards per m ² |
| Product code | MDE176R |



Subframe
See page 58



Alternative uses
See page 78



Product samples
See page 82



Discover more about Burnt Cedar:
millboard.co.uk/burnt-cedar

Find an Approved Installer or Premier Distributor:
millboard.co.uk/locator



"These boards gave us exactly what we wanted, and they are low maintenance, too."

Charlotte Homeowner



Enhanced Grain Golden Oak

An enduring, versatile classic, Golden Oak offers the appealing look of newly sawn, natural oak timber, with a light golden hue that retains its stylish appearance over time.

Golden Oak's warm tones serve as the perfect backdrop to many different tastes and preferences. Add distinction with this handsome and pleasingly traditional board.

| | |
|--------------|--------------------------------|
| Board size | 176 x 3600 x 32mm |
| Coverage | 1.54 boards per m ² |
| Product code | MDE176G |



Subframe
See page 58



Alternative uses
See page 78



Product samples
See page 82



Discover more about Golden Oak:
millboard.co.uk/golden-oak

Find an Approved Installer or Premier Distributor:
millboard.co.uk/locator



"The handsome Golden Oak style offset our New England design perfectly."

Cathy Homeowner



Enhanced Grain Coppered Oak

An autumnal rich finish with a profound depth of colour, Coppered Oak creates a look reminiscent of high-quality hardwoods such as ipe or teak.

Imbue your relaxing outdoor space with the natural vibrance, texture and tone of this russet-brown shade, moulded from smooth, organic timbers.

| | |
|--------------|--------------------------------|
| Board size | 176 x 3600 x 32mm |
| Coverage | 1.54 boards per m ² |
| Product code | MDE176C |



Subframe
See page 58



Alternative uses
See page 78



Product samples
See page 82



Discover more about Coppered Oak:
millboard.co.uk/coppered-oak

Find an Approved Installer or Premier Distributor:
millboard.co.uk/locator

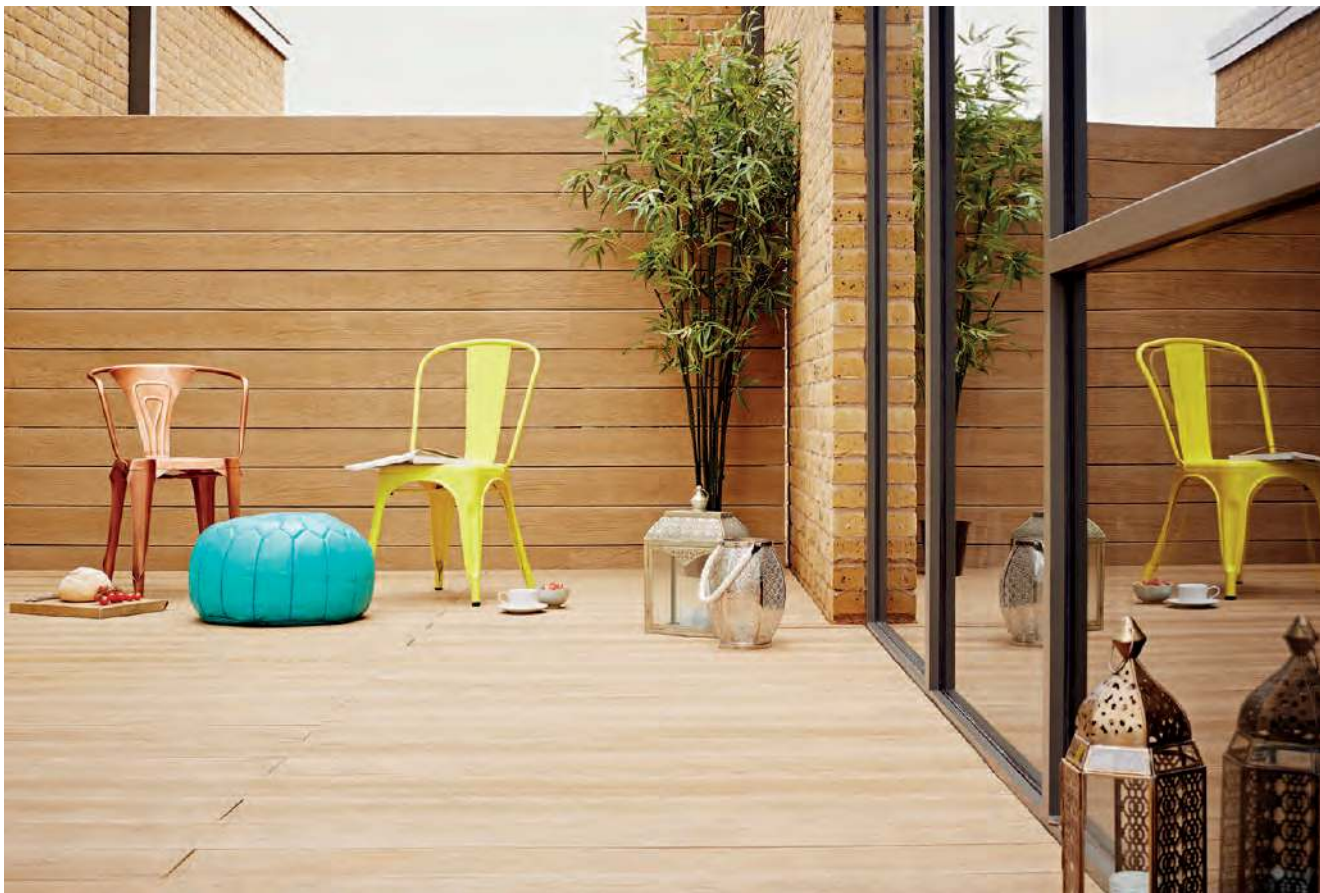

Enhanced Grain

Jarrah

A deep, burnt-sienna hue inspired by the timber of the native Australian Eucalyptus tree, Jarrah has warm, earthy tones that feel at home in a variety of situations.

Bring an exotic sense of luxury to your outdoor space with Jarrah. With its smooth visage and tropical colouration, Jarrah calls to mind remote sun-drenched islands, rainforests and retreats.

| | |
|--------------|--------------------------------|
| Board size | 176 x 3600 x 32mm |
| Coverage | 1.54 boards per m ² |
| Product code | MDE176J |



Subframe
See page 58



Alternative uses
See page 78



Product samples
See page 82



Discover more about Jarrah:
millboard.co.uk/jarrah

Find an Approved Installer or Premier Distributor:
millboard.co.uk/locator



RESIDENTIAL CASE STUDY

Brentwood House, Essex

The owners of Brentwood House in Essex wanted to update their brick and paving slab terrace. The existing arrangement was difficult to keep clean and patches of algae made it dangerous, especially during the winter. A local firm was brought in to redesign the space, with a brief to extend the terrace and to create a stylish, contemporary look.

Brentwood House's stunning new terrace includes an expansive space for entertaining friends and family. The built-in seating is flanked by a glass balustrade and atmospheric lighting, achieving a practical and attractive end-result.

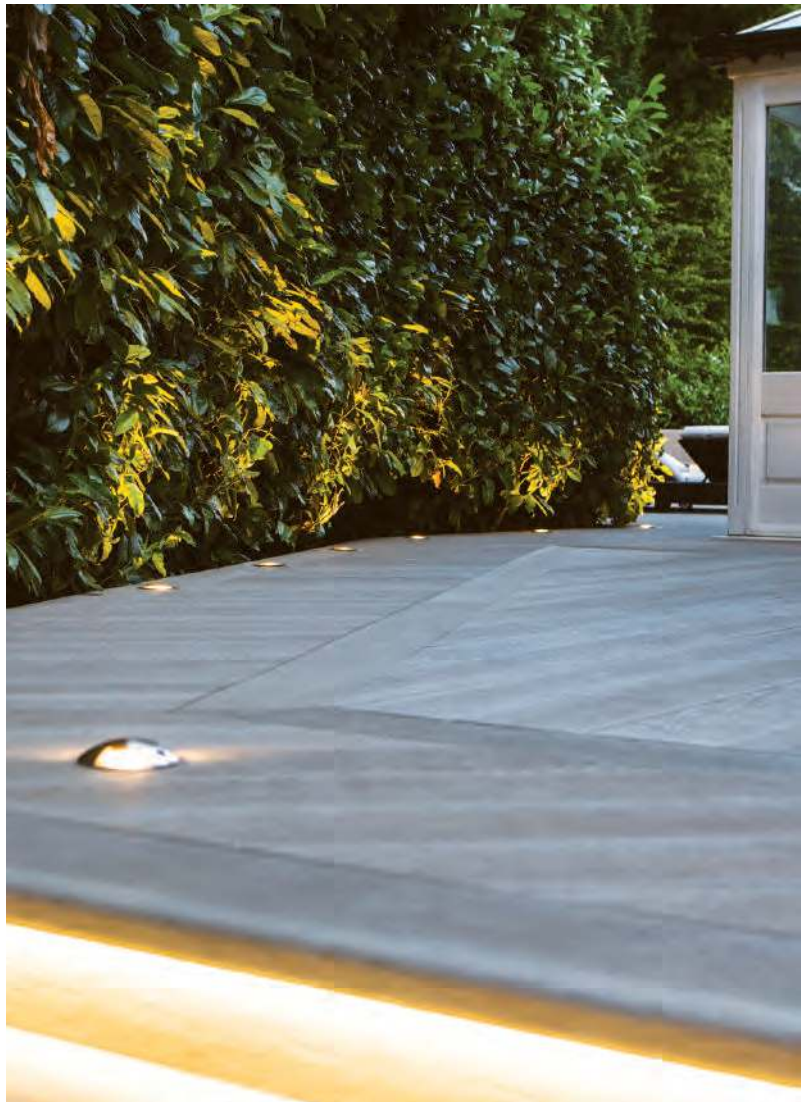

For the terrace's surface itself, Millboard Enhanced Grain decking in Smoked Oak was chosen both for its visual appeal and for its high-performance characteristics. Millboard's flexible Bullnose edging was also used to create a chic curved seating area. The whole installation has great slip-resistance, even in the wet, and just requires cleaning to sustain the deck's good looks.

Enhanced Grain Smoked Oak

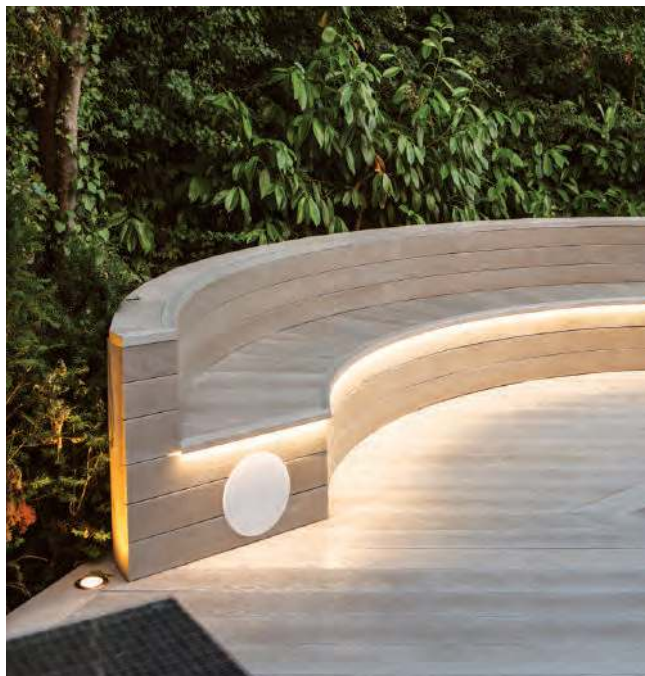

"Millboard decking provided an ideal surface for what the clients required. It looks superb and it needs little maintenance to stay that way."

INSTALLER

RESIDENTIAL CASE STUDY

Vicar's Hill, Ladywell

The steep slopes of the existing garden at this property consisted largely of an uneven grass lawn and a few tired plants. It offered little to the owners and their three children, so they commissioned a designer to create a garden that all members of the family could use for relaxation and play.

The garden has been transformed into a space with distinctive areas for relaxing and having fun. Millboard decking has been used to create a raised platform at the entrance to the house, a mid-level deck extending out over the area below, overlapping steps that lead from the lawn area to a sunken trampoline, and a sundeck on top of a new garden studio.

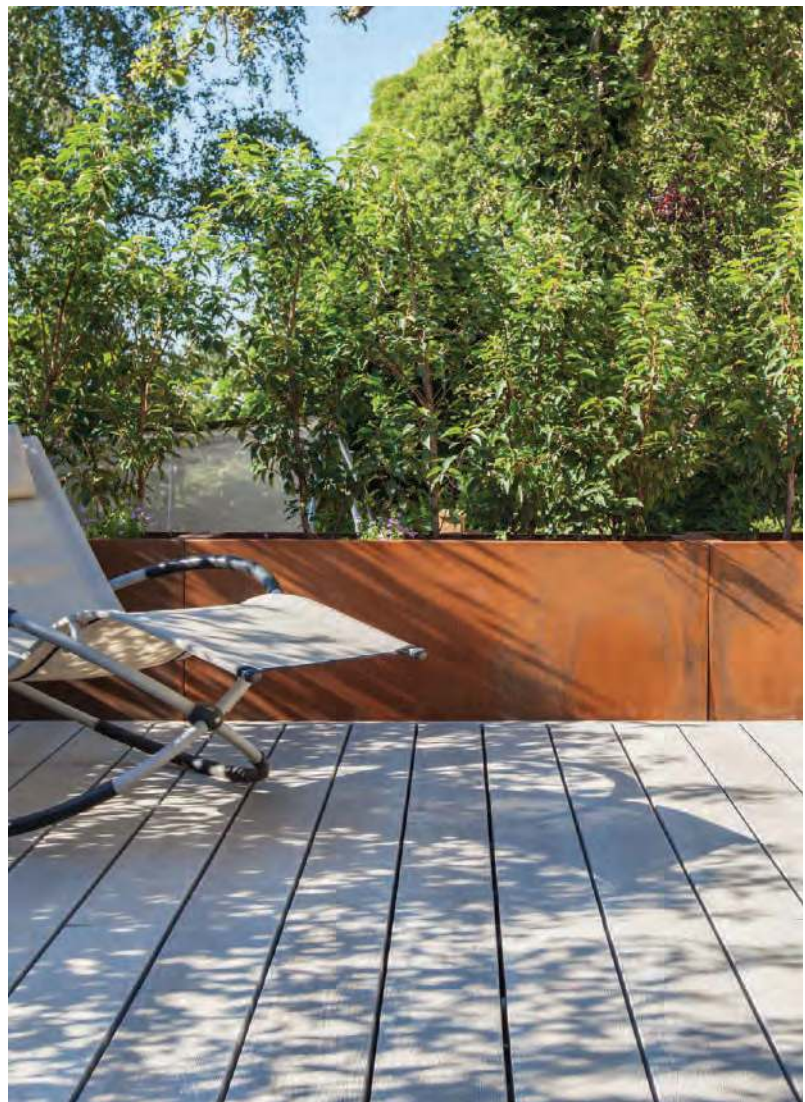

Millboard's Plas-Pro sub-frame components were used to ensure all the underlying structures will last as long as the decks they support.

Requirement

New design for multi-level garden

Project location

London, UK

Designer

Simon Orchard Garden Design

Enhanced Grain Smoked Oak



"Millboard was the perfect choice for this project, offering great performance and requiring little maintenance on the part of my busy clients. It's a great product."

GARDEN DESIGNER SIMON ORCHARD GARDEN DESIGN

COMMERCIAL CASE STUDY

East India Dock, London

Studio RHE, the London-based architecture and design practice, set out their plans to remodel Clove Crescent, East India Docks. The space would provide a new public realm, become a 'workplace of the future' and an icon of the capital's regeneration.

Millboard supplied 860m² of Enhanced Grain decking in Golden Oak, together with matching fascia boards. Representatives from Millboard offered technical design assistance to Studio RHE throughout the project.

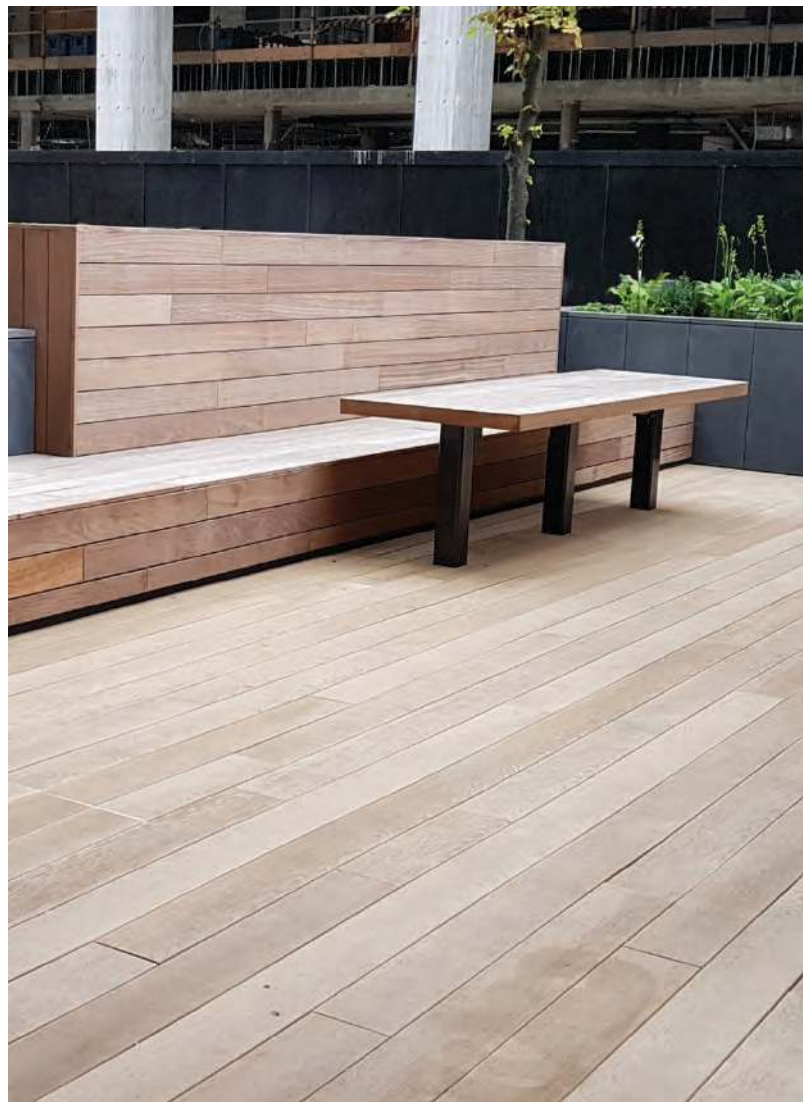

Studio RHE's £25m project includes cost-effective office spaces flanked by cutting-edge amenities and relaxing communal areas. The central public water garden features an oasis of trees, landscaped ponds and seating. Studio RHE's decision to use Millboard decking throughout was based on the product's durability, its suitability for use in a wet zone and for its stunning good looks.

Enhanced Grain Golden Oak



"We were looking to create a boardwalk feel to the edge of the proposed public realm to give a warmer natural touch to the water's edge, adjacent to vibrant and verdant planting. As the public realm included a water garden and was open to the public, slip resistance was one of the most important requirements to the project."

ARCHITECT STUDIO RHE

COMMERCIAL CASE STUDY

Southampton Harbour Hotel

A bustling port and gateway to the Solent, Southampton Harbour also enjoys an international reputation for hosting the annual Boat Show. In recent years, the Ocean Village development has been adding to the area's prestige.

HGP Architects were engaged to create a five-star hotel for the marina and they came up with a spectacular design. Southampton Harbour Hotel looks like a luxury ocean liner moored on the waterfront, with terraces on multiple levels. High-end decking was required for all the terraces, and as well as looking good, materials had to be able to withstand the waterside location: slip-resistant and non-rot properties were vital.



The 1500m² installation is built on a Plas-Pro subframe and perfectly meets the brief for a durable and glamorous finish. The hotel recently won the prestigious C&IT Hotel of the Year award – a well deserved win for a boldly imagined property.

Our Flexible Bullnose Edging in Burnt Cedar was also used to create a visual contrast to the step up to the decking.

Enhanced Grain Smoked Oak





The Collection:

Weathered Oak

Create an atmosphere with our timeless, elegant boards



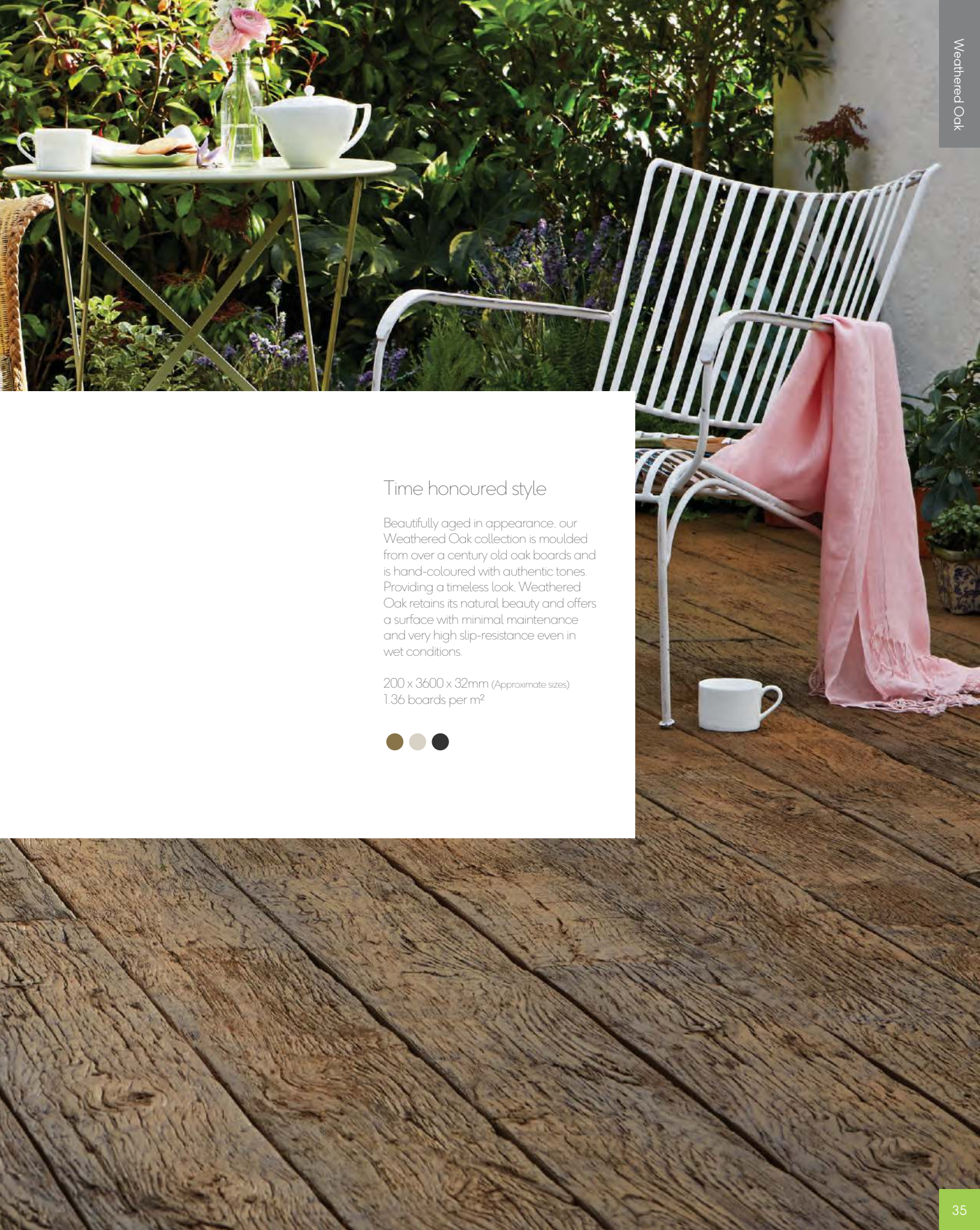

Time honoured style

Beautifully aged in appearance, our Weathered Oak collection is moulded from over a century old oak boards and is hand-coloured with authentic tones. Providing a timeless look, Weathered Oak retains its natural beauty and offers a surface with minimal maintenance and very high slip-resistance even in wet conditions.

200 x 3600 x 32mm (Approximate sizes)
1.36 boards per m²



Weathered Oak

Vintage

Achieve the classic beauty of a natural, weathered oak finish. Vintage is styled with darker tones that work perfectly in country retreats, coastal getaways and chic city courtyards.

Tastefully aged and utterly timeless, our Vintage colour option adds a stately and refined look to any space.

| | |
|--------------|--------------------------------|
| Board size | 200 x 3600 x 32mm |
| Coverage | 1.36 boards per m ² |
| Product code | MDW200V |



Subframe
See page 58



Alternative uses
See page 78



Product samples
See page 82



Discover more about Vintage:
millboard.co.uk/vintage

Find an Approved Installer or Premier Distributor:
millboard.co.uk/locator

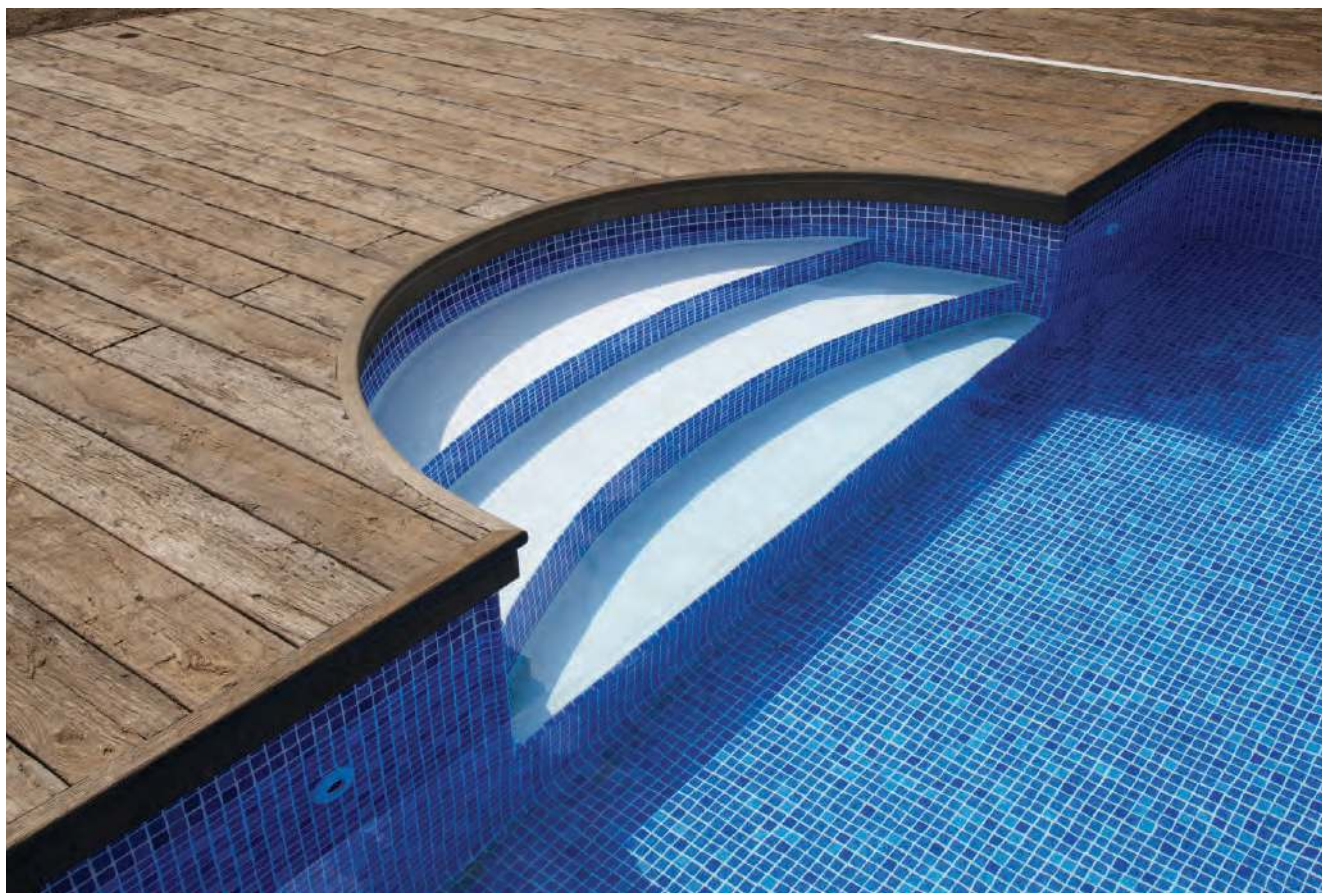

"The Vintage colour enabled us to cultivate the traditional country garden look that we wanted."

Theo Homeowner



Weathered Oak Driftwood

Our Driftwood boards have the incomparable look of sea-washed timber. Driftwood's subtle hue and characterful texture create an easy, relaxed style, ideal for laid-back coastal living.

Reminiscent of tidal landscapes, Driftwood creates a bohemian, escapist getaway and works perfectly alongside swimming pools and outdoor features.

| | |
|--------------|--------------------------------|
| Board size | 200 x 3600 x 32mm |
| Coverage | 1.36 boards per m ² |
| Product code | MDW200D |



Subframe
See page 58



Alternative uses
See page 78



Product samples
See page 82



Discover more about Driftwood:
millboard.co.uk/driftwood

Find an Approved Installer or Premier Distributor:
millboard.co.uk/locator



Weathered Oak Embered

Richly textured and dramatically chic, Embered provides a sensational stage or backdrop to a glamorous outdoor space.

By combining the look of Eastern heritage techniques with contemporary engineering, Millboard's Embered boards achieve the sought-after style.

| | |
|--------------|--------------------------------|
| Board size | 200 x 3600 x 32mm |
| Coverage | 1.36 boards per m ² |
| Product code | MDW200R |



Subframe
See page 58



Alternative uses
See page 78



Product samples
See page 82



Discover more about Embered:
millboard.co.uk/embered

Find an Approved Installer or Premier Distributor:
millboard.co.uk/locator



"The decking boards have arrived, and they are absolutely gorgeous. Even better than imagined. We will certainly be showing these off."

Mr & Mrs Robinson Homeowners



RESIDENTIAL CASE STUDY

Burnham-on-Sea, Somerset

A local garden landscaper, based in Portishead, North Somerset, was commissioned to design an entirely fresh outdoor scheme for this seaside property. Alongside their planting scheme, GreenBird's proposed hard landscaping features included an expansive deck where the owners could relax and enjoy alfresco dining.

The new garden creates a wonderfully relaxed feel and, thanks to subtle lighting, is as enjoyable after dark as during the daytime.



Millboard's Weathered Oak in its Driftwood guise was the ideal complement to this garden design project, with its characterful grain supplying the instant impression of age.

The superb looks are matched by its performance. Unlike wood, it will not rot, warp or split and just needs cleaning to sustain its natural looks.

Last but not least, Weathered Oak's excellent slip-resistance means that even after rain, the deck can be safely enjoyed.

Weathered Oak Driftwood



"When our garden landscaper first proposed such an amount of decking, we were quite nervous about the maintenance required. After seeing a sample of Millboard decking, we were reassured. The end result is superb, both exceeding our expectations and allaying any initial worries that we had about keeping it looking good in the future."

HOMEOWNER

RESIDENTIAL CASE STUDY

Newent, Gloucestershire

The discerning homeowners wanted to transform their relatively plain 1960s property into something more suited to their tastes. Engaging a reputable construction company, they embarked on a significant overhaul, which included outdoor landscaping.

The extensive outdoor area blends a tasteful mix of materials and includes a covered eating area, a nature pond and a swimming pool. Millboard Weathered Oak decking was applied to the main decked area, the walkways to pond and pool, and even a sliding cover for the pool.

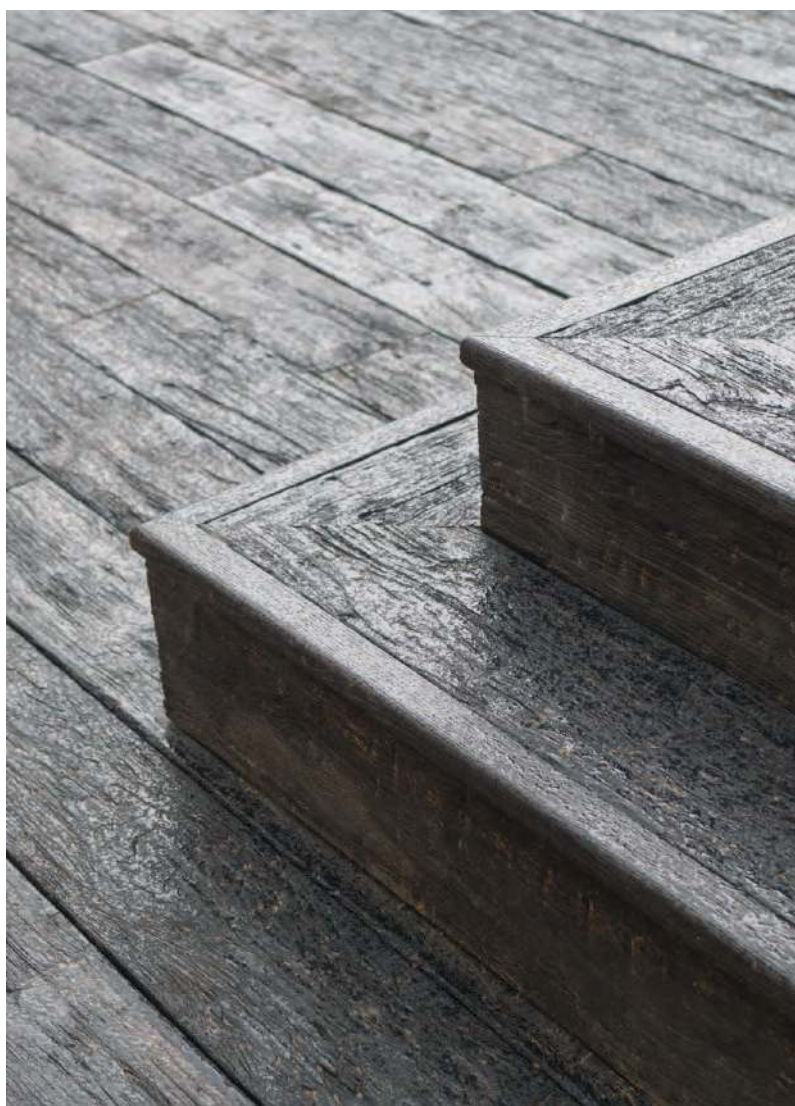

Millboard Weathered Oak decking in the Embered shade was chosen for all the decked areas. Providing the distinctive character of 100-year-old timber, but with the performance of a modern, cutting-edge material, it is perfectly suited to waterside environments and maintains high slip-resistance even when wet.

Weathered Oak Embered



"We thoroughly enjoyed working with the product. Combined with the Plas-Pro sub deck material, fixed with stainless steel fixings, our client can rest assured that the Millboard deck will outlast all of us!"

DIRECTOR T J VEALE CONSTRUCTION LTD

COMMERCIAL CASE STUDY

Royal Botanic Gardens, Kew

Kew Gardens seek to preserve the natural environment, protect endangered species, as well as discovering new and sustainable uses for plants and fungi. It is estimated that the 14,000 trees that have been planted at Kew draw around 8.6 tonnes of potentially harmful carbon dioxide from London's air annually.

Kew Gardens is a UNESCO World Heritage Site and one of London's top tourist attractions, playing host to more than 3 million visitors annually. With such heavy footfall, durability was a key consideration when specifying materials for flooring and furniture applications and Millboard decking was selected as the best fit. The Millboard projects team provided the contractor with ongoing support, including site visits and close collaboration with the designers and installers throughout.



Every length of Millboard decking is designed to look and feel indistinguishable from real timber, without the associated drawbacks. It is this attention to detail that has led Kew Gardens and other leading establishments to specify the Enhanced Grain and Weathered Oak range for walkways, furniture and cladding applications.

A beautiful, reliable and eco-conscious solution that will help to encourage future generations to live life outside.

Weathered Oak Embered



“Having previously specified Millboard products on design projects for schools, I knew that I could rely on the range for its durability and slip-resistant properties, on top of its natural aesthetic. The black hues of these boards provide a good backdrop for foliage plants, allowing their vibrant colours to really shine through. The Children’s Garden incorporates an amphitheatre design with curved benches; we achieved a good radius by simply bending the fascia boards to create a seamless finish that’s not always possible with timber. The Millboard decking was installed just as easily as real wood, and facilitated techniques like tapered cuts, which help to create that flawless finish we were looking for. It blends really well.”

LANDSCAPE ARCHITECT KEW GARDENS



The Collection:

Lasta-Grip

Safety-focused boards with style

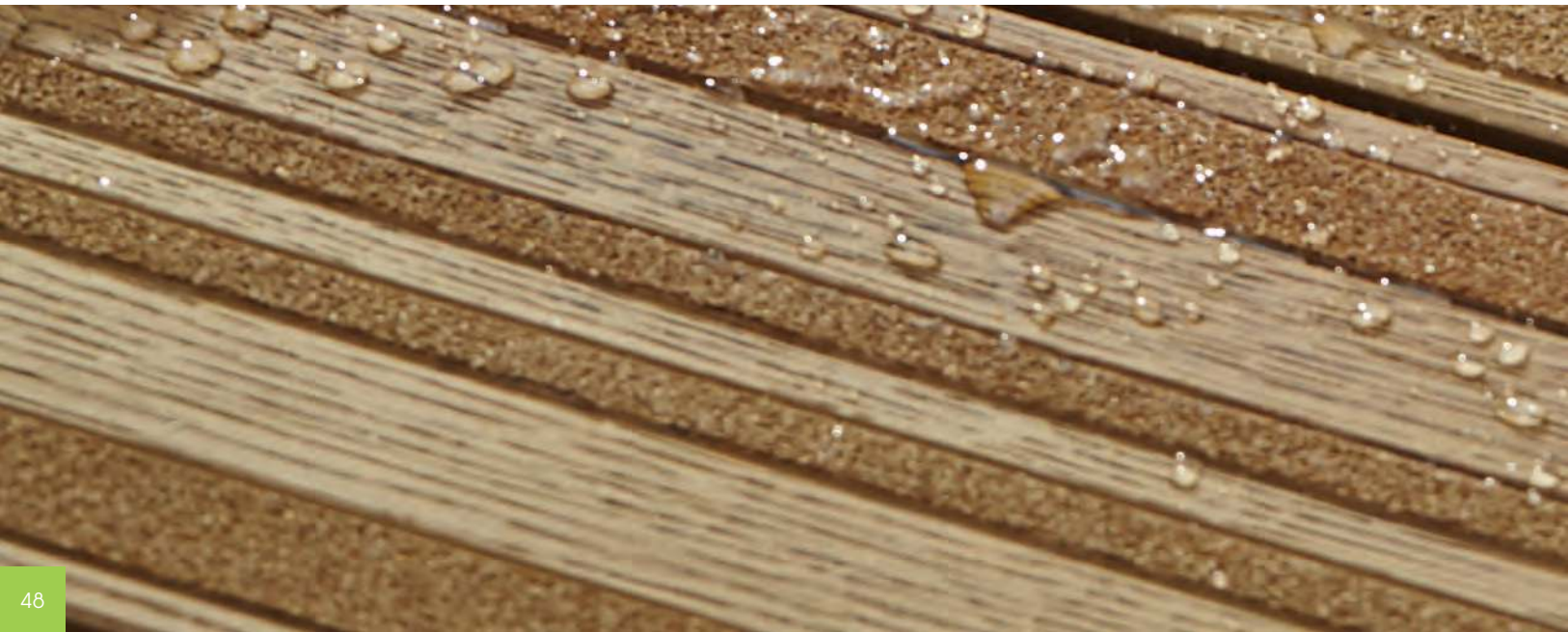

A gripping design

Our Lasta-Grip® collection combines the attractive appearance of our Enhanced Grain boards with a unique textured design that offers outstanding slip-resistance, without the rough feel of conventional gritted strip boards. Perfect for commercial areas where safety is paramount, but appearance is important.

200 x 3600 x 32mm (Approximate sizes)
1.36 boards per m²



Lasta-Grip Coppered Oak

Lasta-Grip in the popular Coppered Oak shade provides a tasteful decking option for areas where the shades of hardwood are desirable but visible slip-resistant measures are required. The beautiful wood grain is still clearly evident, and the textured strips provide reassurance that safety needs are fully met.

| | |
|--------------|--------------------------------|
| Board size | 200 x 3600 x 32mm |
| Coverage | 1.36 boards per m ² |
| Product code | MDL200C |



Lasta-Grip Golden Oak

Maintaining the same appeal as in the Enhanced Grain range, our Lasta-Grip Golden Oak decking provides the elegant look of freshly sawn Oak. Combining the distinctive wood grain with textured strips for maximum slip-resistance, these decking boards are as safe as they are stylish, and suitable for both residential and commercial environments.

| | |
|--------------|--------------------------------|
| Board size | 200 x 3600 x 32mm |
| Coverage | 1.36 boards per m ² |
| Product code | MDL200G |



Discover more about Lasta-Grip decking:
millboard.co.uk/lasta-grip-decking



The Collection:

Edging & Fascia

The perfect finishing touch

Completing the look

Millboard edging continues the beautiful wood grain right round the edge profile to maintain the authentic wood look.

Designed to resist high wear points, our edging profiles and fascia boards come in all of the Millboard colours to match the rest of your deck. And the specialist flexible edging fits easily around curved edges for a truly distinctive outdoor space.



Edging & Fascia

Open up a whole range of possibilities – from under-lip lighting to coping for planters and seating – with Millboard's Edging and Fascia.

Our finishing touches add exceptional stability and aid ease of installation on steps and other exposed edges. Achieve a refined look that adds distinction to any setting.

Square Edging

Construction: Polymer resin core/Lastane® surface

Size: 50 x 3200 x 32mm

Fascia

Construction: Polymer resin core/Lastane® surface

Size: 146 x 3200 x 16mm

Flexible Bullnose Edging

Construction: Flexible polymer resin core/Lastane® surface

Size: 50 x 2400 x 32mm

Bullnose Board

Construction: Polymer resin core/Lastane® surface

Size: 150 x 3200 x 32mm

-
- ← Smoked Oak with Bullnose Board
 - ↓ Brushed Basalt with Flexible Bullnose Edging and Fascia
 - ↓ Golden Oak with Flexible Bullnose Edging and Fascia





Edging & Fascia: Colour options

1 Smoked Oak/Driftwood

Flexible Bullnose Edging: MEBF50D
 Square Edging: MEUN32D
 Fascia: MFN320D
 Bullnose Board: MEBB150D

4 Burnt Cedar/Embered

Flexible Bullnose Edging: MEBF50R
 Square Edging: MEUN32R
 Fascia: MFN320R
 Bullnose Board: MEBB150R

7 Jarrah

Flexible Bullnose Edging: MEBF50J
 Square Edging: MEUN32J
 Fascia: MFN320J
 Bullnose Board: MEBB150J

2 Limed Oak

Flexible Bullnose Edging: MEBF50L
 Square Edging: MEUN32L
 Fascia: MFN320L
 Bullnose Board: MEBB150L

5 Golden Oak

Flexible Bullnose Edging: MEBF50G
 Square Edging: MEUN32G
 Fascia: MFN320G
 Bullnose Board: MEBB150G

8 Vintage

Flexible Bullnose Edging: MEBF50V
 Square Edging: MEUN32V
 Fascia: MFN320V
 Bullnose Board: MEBB150V

3 Brushed Basalt

Flexible Bullnose Edging: MEBF50B
 Square Edging: MEUN32B
 Fascia: MFN320B
 Bullnose Board: MEBB150B

6 Coppered Oak

Flexible Bullnose Edging: MEBF50C
 Square Edging: MEUN32C
 Fascia: MFN320C
 Bullnose Board: MEBB150C

9 Antique Oak

Flexible Bullnose Edging: MEBF50A
 Square Edging: MEUN32A
 Fascia: MFN320A
 Bullnose Board: MEBB150A

Please note all edging/fascia profiles come with the smoother grained finish of the Enhanced Grain boards as shown above, rather than the deep profiled finish of the Weathered Oak boards.

The Collection:

Subframes

Durable framework providing structural integrity and design flexibility

The finest support

Our DuoSpan subframe and DuoLift support systems enable straightforward construction of complex decks, screening and landscaping structures. These innovative new additions to Millboard's range have been designed to a high specification, meeting British and EU standards.

The patent pending systems combine lightweight ease of handling with solid stability once installed.



The intuitive DuoSpan and DuoLift systems create durable and distinctive designs.

DuoSpan and DuoLift. Engineered strength and design versatility.

Representing a unique landscape construction frame, DuoSpan combines the strength of aluminium with the design flexibility of recycled plastic. This combination enables distinctive decking designs and outdoor structures that would be difficult with most conventional subframes, and its slot-and screw assembly, assists with easier installations.

The DuoLift joist support system provides substantial height flexibility within four stackable components, removing the challenge of various fixed-height pedestals over a single area, and provides enhanced ease of installation, together with superior load bearing.

DuoSpan and DuoLift have been designed by industry professionals to comply with Eurocode 1: Actions on Structures (BS EN 1991-1-1), and can both be used with a wide range of decking and cladding materials.



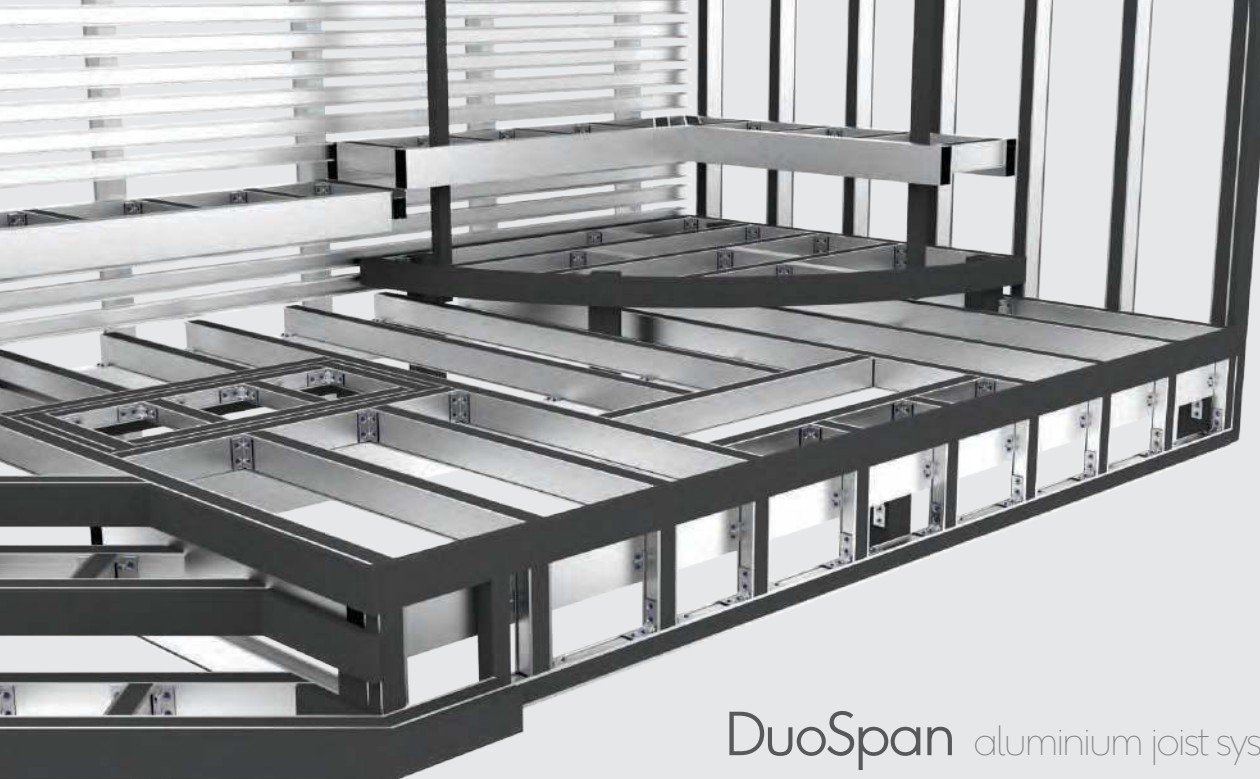

DuoSpan aluminium joist system

DuoSpan is packed with innovative features that make installation success a virtual certainty, even with distinctive and challenging designs. DuoSpan is available in a low level profile, or with deeper profiles for longer spans.

www.millboard.co.uk/duospan



DuoLift twist-lock support system

Simple stackability for height flexibility – DuoLift provides subframe support that just works. The Self-Levelling Joint is designed for ease and speed of installation. An adjustable and problem-solving solution from Millboard.

www.millboard.co.uk/duolift

DuoSpan

DuoSpan is a unique landscape construction frame, combining the strength of aluminium with the design flexibility of recycled plastic. This combination enables distinctive design opportunities for decking and outdoor structures that would be impossible with conventional subframes.



Flexible connectivity

Multiple bracket types facilitate all types of joints, including Flexible Brackets for non-standard angles.

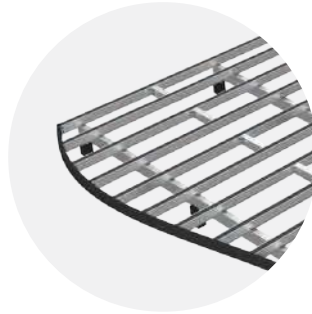

Unique curved constructions

The combination of rigid DuoSpan with flexible Plas-Pro enables the construction of stunning curved formations.



Slot-and-screw assembly

Screw-locating grooves and self-drilling screws ensure accurate alignment and a fast fix that's right first time.



Exceptional spans

The DuoSpan 99mm Joist provides an 1800mm span in residential applications, reducing posts or joist supports required.



Corrosion-resistant

Galvanic corrosion between different metals is minimised with our cathodic barrier fixings.

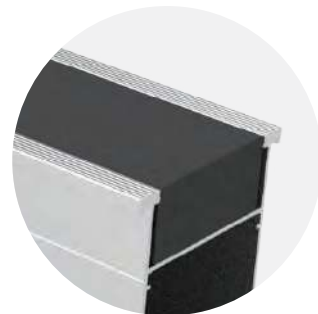

Simple, stable fixing

Decking and cladding can be easily and securely screwed into the DuoSpan Joist Insert at almost any angle.

DuoLift

The DuoLift joist support system was designed to make installation significantly easier and to ensure successful outcomes. Providing substantial height flexibility within four stackable components, DuoLift removes the common problem of having to order varying height pedestals for a single area.



Superior load bearing

The larger 114mm diameter Joist Cradle and 220mm diameter Foot provide enhanced dispersion of point loading.



Micro-adjustable

The height-adjustment ring on the DuoLift Joist Cradle provides precision 1mm adjustments for every quarter turn.



Self-levelling

The 20mm Self-Levelling Joint component is added for height elevation of more than 35mm and ensures level surfaces.



Stack-up support

Eliminating conventional fixed-height pedestals, stackable 45mm Risers provide on-site flexibility and accuracy.



Locking tabs

Locking tabs twist over the bottom lip of DuoSpan Joists for secure anchoring or align with solid joists for a screw fixing.



Visible twist-lock

Clear indicators confirm that stackable components are properly locked together – just insert, twist and lock.



DuoSpan

DuoSpan profiles

| Contents | Dimensions | Material | Code |
|----------------------|-------------------|-----------|-----------|
| A DuoSpan 51mm Joist | 51 x 68 x 3600mm | Aluminium | K5168J360 |
| B DuoSpan 99mm Joist | 99 x 68 x 3600mm | Aluminium | K9968J360 |
| C DuoSpan 136mm Beam | 136 x 63 x 3600mm | Aluminium | K1363B360 |



A



D



B



E

DuoSpan insert

| Contents | Dimensions | Material | Code |
|------------------------|------------------|------------------|-----------|
| D DuoSpan Joist Insert | 25 x 54 x 2400mm | Recycled plastic | K2554B240 |

Plas-Pro

| Contents | Dimensions | Material | Code |
|---------------------------|--------------------|------------------|-----------|
| E Plas-Pro Fascia Support | 100 x 25 x 3000mm | Recycled plastic | P0210B300 |
| F Plas-Pro Post | 100 x 100 x 3000mm | Recycled plastic | P1010B300 |



Accessories and fixings

Joist bracket sets for DuoSpan 51mm Joist

| Contents | Quantity | Dimensions | Material | Box code |
|-------------------------------|----------|------------|-----------------------------|----------|
| DuoSpan 51 90° Angle Bracket | 10 | – | Aluminium | K51RP010 |
| DuoSpan Hex-head Screw | 42 | 6.3x25mm | Cathodic barrier coated s/s | |
| DuoSpan 51 Flexible Bracket | 10 | – | Aluminium | K51FP010 |
| DuoSpan Hex-head Screw | 42 | 6.3x25mm | Cathodic barrier coated s/s | |
| DuoSpan Pan-head Screw | 20 | 5 x 25mm | Cathodic barrier coated s/s | |
| DuoSpan 51 Straight Connector | 10 | – | Aluminium | K51LP010 |
| DuoSpan Hex-head Screw | 42 | 6.3x25mm | Cathodic barrier coated s/s | |

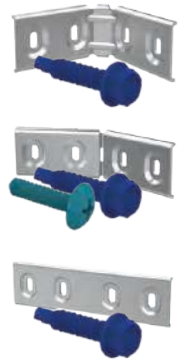

Joist bracket sets for DuoSpan 99mm Joist

| Contents | Quantity | Dimensions | Material | Box code |
|-------------------------------|----------|------------|-----------------------------|----------|
| DuoSpan 99 90° Angle Bracket | 10 | – | Aluminium | K99RP010 |
| DuoSpan Hex-head Screw | 42 | 6.3x25mm | Cathodic barrier coated s/s | |
| DuoSpan 99 Flexible Bracket | 10 | – | Aluminium | K99FP010 |
| DuoSpan Hex-head Screw | 42 | 6.3x25mm | Cathodic barrier coated s/s | |
| DuoSpan Pan-head Screw | 20 | 5 x 25mm | Cathodic barrier coated s/s | |
| DuoSpan 99 Straight Connector | 10 | – | Aluminium | K99LP010 |
| DuoSpan Hex-head Screw | 42 | 6.3x25mm | Cathodic barrier coated s/s | |



Hold-down clip

| Contents | Quantity | Dimensions | Material | Box code |
|------------------------|----------|------------|-----------------------------|----------|
| DuoSpan Hold-down Clip | 30 | – | Aluminium | K48CP030 |
| DuoSpan Hex-head Screw | 32 | 6.3x25mm | Cathodic barrier coated s/s | |



Plas-Pro profile fixings

| Contents | Quantity | Dimensions | Material | Box code |
|-----------------------------------|----------|------------|-----------------------------|----------|
| DuoSpan Bracket to Plas-Pro Screw | 100 | 5 x 25mm | Cathodic barrier coated s/s | FD25P100 |
| Plas-Pro to DuoSpan Screw | 100 | 5 x 50mm | Cathodic barrier coated s/s | FD50P100 |



DuoLift

DuoLift has been developed by Millboard based on intimate knowledge of the challenges of installing decking on hard surfaces, and the shortcomings of conventional pedestal/cradle systems. It removes the arbitrary choice of pedestal heights, and instead provides a 15-60mm Joist Cradle with a sequence of support components that can raise the height to a maximum of 350mm.

Making installation easy

Every aspect of the installer's experience has been considered, and fine details of the design make height adjustment easier and give confidence when installing. The larger 114mm diameter of the Joist Cradle and the 220mm diameter of the Foot provide more effective load spreading.

Twist-lock system

To ensure the best solid fit, the DuoLift boasts the twist-lock system, rather than a loose stacking.

DuoLift unpacked

DuoLift Joist Cradle 15-60mm

10 pack: PMCP010

Providing an exceptional height range of 45mm, from 15-60mm, the DuoLift Joist Cradle enables precision height adjustment with 5mm markings on the side and each quarter turn of the adjustment ring representing a 1mm rise or fall. The Joist Cradle allows the installer to adjust the height whilst the joist is in place, locking tabs provide a secure finish once correct height has been determined.



DuoLift Self-Levelling Joint 20mm

10 pack: PMLP010

Adding 20mm to the height of the supports, the DuoLift Self-levelling Joint provides easy and effective levelling of a subframe up to 5°, ready for decking installation. Suitable for standing directly onto a solid substrate, or for providing a joint for a higher support.

DuoLift Riser 45mm

10 pack: PMRP010

The Riser component of the DuoLift system increases the height in increments of 45mm. It is capable of sitting directly onto a solid substrate under the Joist Cradle and Self-Levelling Joint or forming part of a higher stack with a foot beneath.

DuoLift Foot 45mm

10 pack: PMFP010

The DuoLift Foot provides a very stable footing for more elevated subframes, raising the height by 45mm and spreading the load further across the substrate, due to the 220mm base supporting a maximum combined height of 350mm.

DuoLift Acoustic Separation Pad 3mm

10 pack: PMAP010

Agglomerated cork and recycled rubber pads offer a layer of protection between joist supports and membranes, as well as providing an acoustic benefit.

Simple stackability for height flexibility

Multiple height combinations from four sturdy components.
With a selection of components on site, installation delays can be avoided.

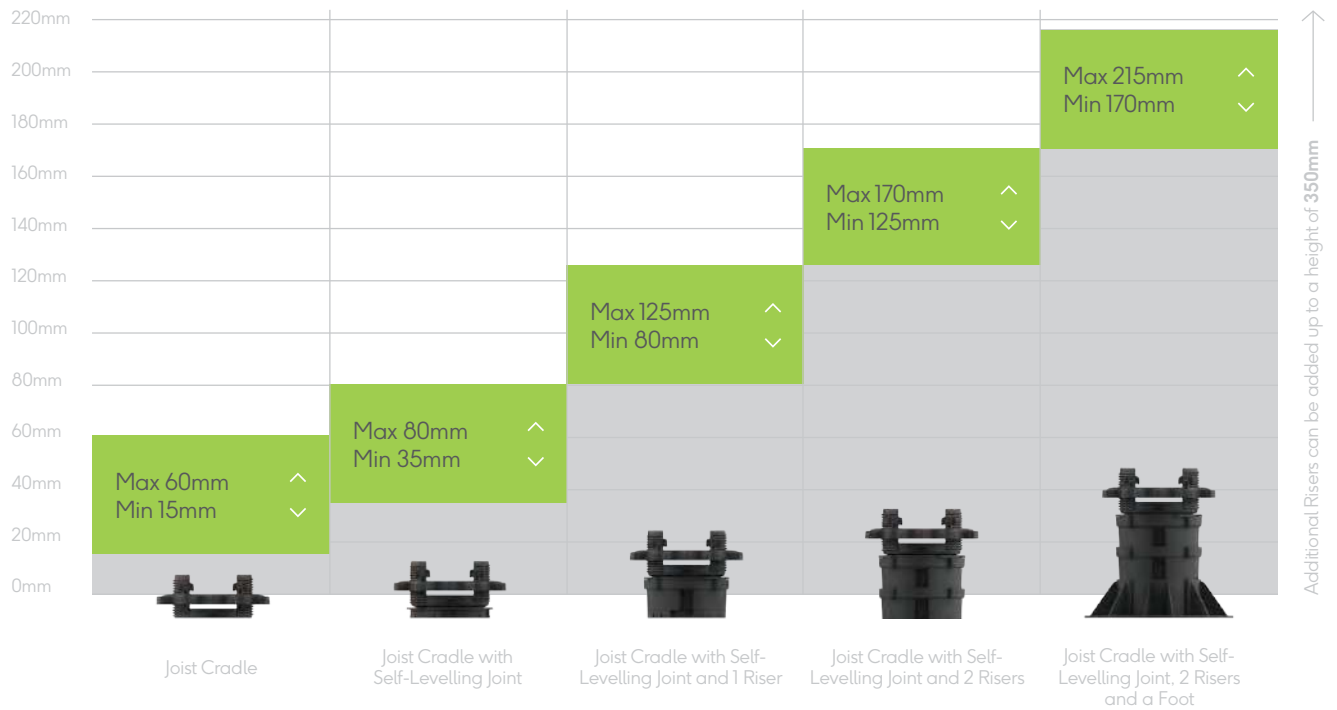

Universal support for all frame types

DuoLift is designed to support a range of joists from DuoSpan to Plas-pro to timber.

How many Joist Supports do I need?

Residential applications: 4 per m² Millboard decking*
Commercial applications: 7 per m² Millboard decking*

| Contents | Quantity | Height | Pack Code |
|-----------------------------------|----------|---------|-----------|
| A DuoLift Joist Cradle | 10 | 15-60mm | PMCP010 |
| B DuoLift Self-Levelling Joint | 10 | 20mm | PMLP010 |
| C DuoLift Riser | 10 | 45mm | PMRP010 |
| D DuoLift Foot | 10 | 45mm | PMFP010 |
| E DuoLift Acoustic Separation Pad | 10 | 3mm | PMAP010 |

* Approximate number - quantities may vary according to project design and choice of subframe used.



Plas-Pro subframe

The Plas-Pro recycled plastic subframe is an excellent alternative to timber for constructing supporting structures for decks, seating, planters and more. It is incorporated within our comprehensive DuoSpan aluminium subframe system, but it can also be used on its own in low-height areas, such as roof terraces, and in waterside areas where use of metal is not advisable.

Constructed from recycled plastic, Plas-Pro is strong, versatile and easy to work with. Available in a range of sizes to act as posts, joists and bearers, it can be cut and drilled just like wood, yet never rots even when placed in water.

The flexibility of Plas-Pro means that it can also be used to create unique and special outdoor constructions, incorporating curves and twists that would be impossible with conventional materials.

Plas-Pro 125 x 50mm Joist/Bearer

Designed to be used in conjunction with Plas-Pro 100 x 100mm Posts when installed over a soil/earth base.

Dimensions 125 x 50 x 3000mm

Product Code P1205B300



Plas-Pro 50 x 50mm Joist

Designed to be used in conjunction with the DuoLift system when installed over a solid/stable substrate.

Dimensions 50 x 50 x 2400mm

Product Code P0505B240



Plas-Pro 60 x 30mm Joist

Designed to be used in low-level areas with a solid/stable base. Not to be raised with cradles.

Dimensions 60 x 30 x 2800mm

Product Code P0603H280



Plas-Pro 100 x 100mm Post

Designed to be used in conjunction with Plas-Pro 125 x 50mm Joist/Bearers when installed over a soil/earth base.

Dimensions 100 x 100 x 3000mm

Product Code P1010B300





The Collection:

Installation Accessories

Everything you need for installation success



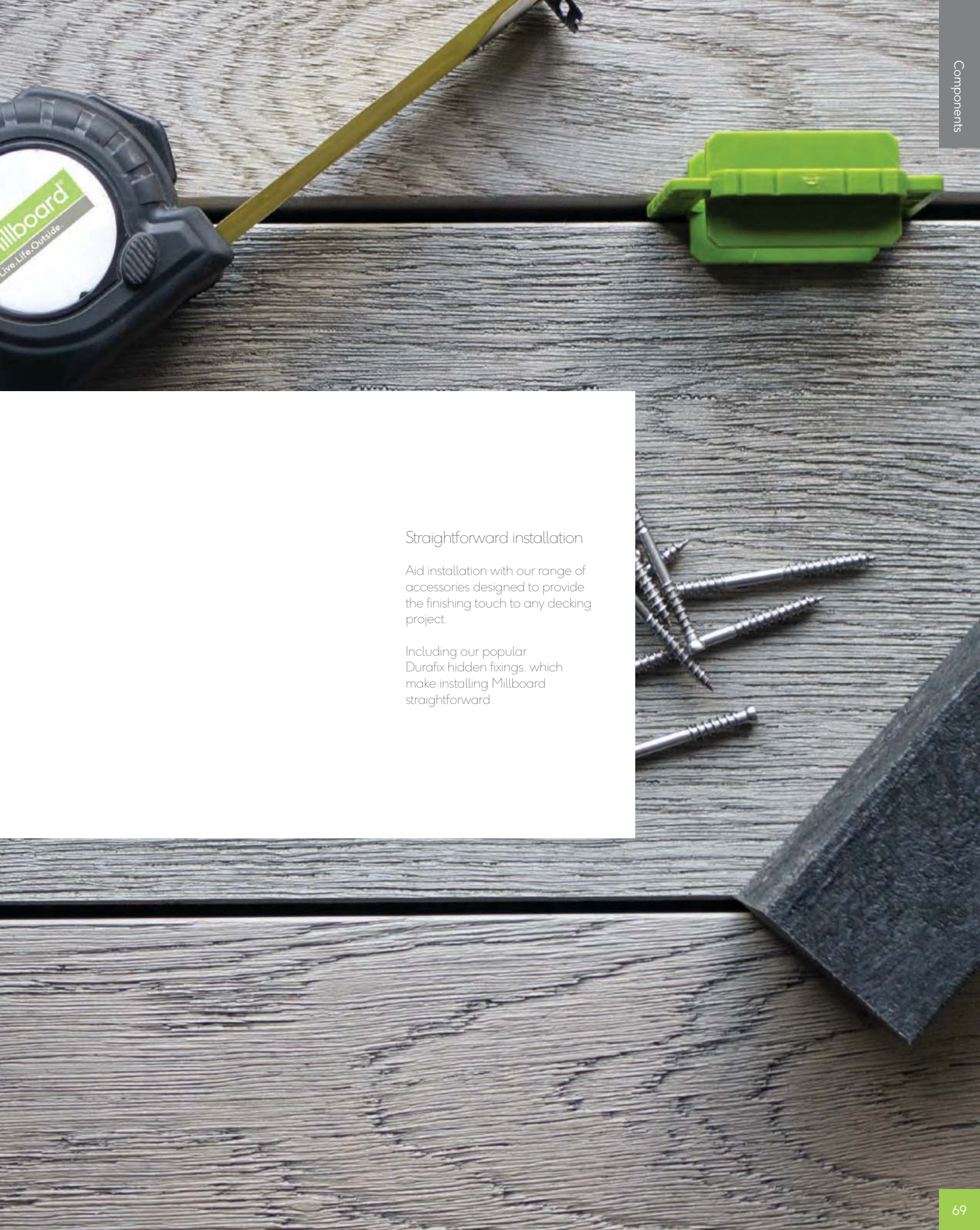

Straightforward installation

Aid installation with our range of accessories designed to provide the finishing touch to any decking project.

Including our popular Durafix hidden fixings, which make installing Millboard straightforward.

Touch-up Coating

Put the finishing touches on exposed cut ends with Touch-up Coating. Supplied in 500ml tins, Touch-up coating is available in nine colours to match your choice of Millboard decking.



A note on colour variance

We go to extraordinary lengths to recreate the look of natural products and therefore intentionally add secondary toning colours. This process means that there may be variance within the same board or between boards.

Whilst every care is taken to ensure consistency, batch-to-batch colour variation is possible. We strongly recommend that you order all you need in one delivery to avoid too much variance. If you do have two batches, it is best to mix them, to blend the colours more seamlessly. It is best to lay the boards out before commencing installation.

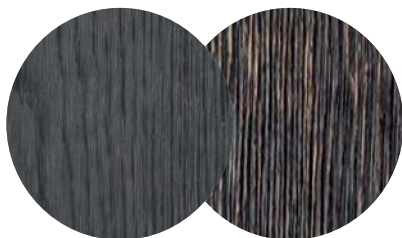

⬆ Colour tone may vary from batch to batch. Antique Oak has more variance between boards.

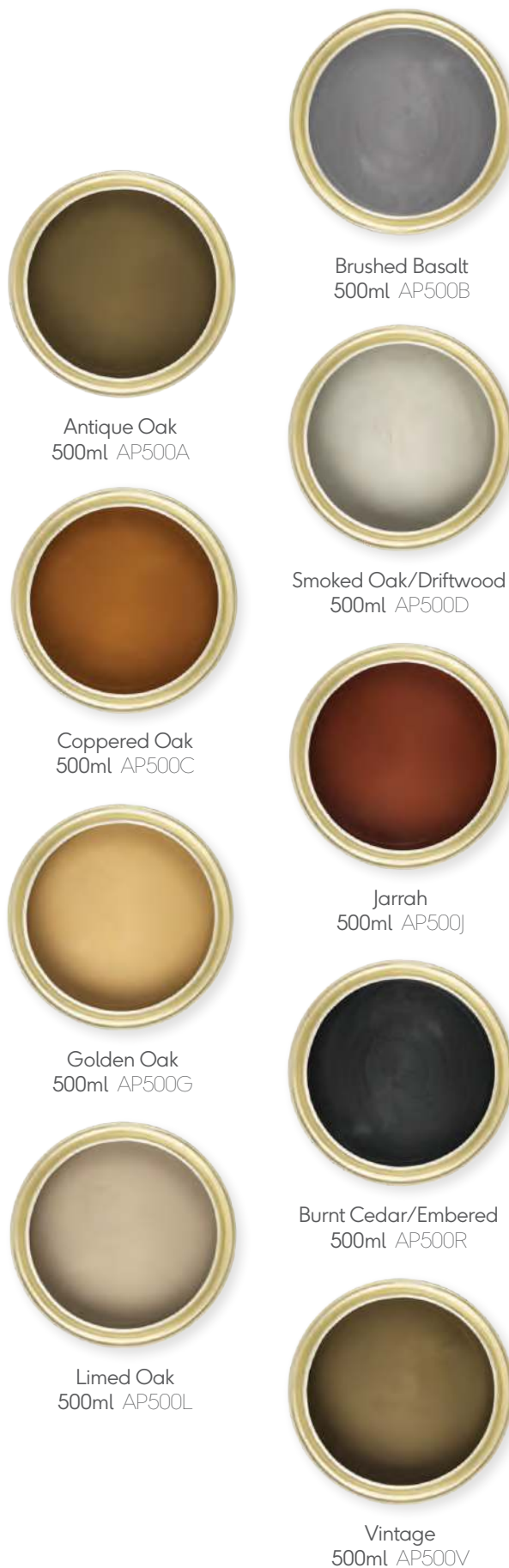

Swatches are representative only. Our Touch-up Coating is intended for cut ends and should not be applied to the top surface of our boards

Durafix® fixings



Our decking system is complemented by our unique Durafix screws, the only recommend fixing when installing Millboard decking.

With Durafix®, there's no need to pre-drill, countersink or use clip fixings. Simply coat in silicone spray, then screw them straight in to just below the surface. Millboard decking's innovative Lastane coating flexes back over the screw-heads, leaving a small witness mark.

Made from A2 stainless steel, the screws have a self-cutting tip, six-point torx head, and are waxed for ease of use. Each box of Durafix® fixings also includes a T15 hex-shank drill bit. You will need around 22 fixings for each length of Millboard decking for residential applications and 26 fixings for commercial applications.

| Fixings | Quantity | Suitable for | Product code |
|------------|------------|---------------------------------|--------------|
| 4.5 x 60mm | Box of 250 | Top down timber and DuoFix tool | FT60P250 |
| 4.5 x 45mm | Box of 250 | Top down DuoSpan and Plas-Pro | FT45P250 |
| 4.5 x 35mm | Box of 100 | Fascia | FT35P100 |

DuoFix installation tool



Our patent pending DuoFix Side-Fixing Guide allows the boards to be fixed through the side, resulting in a hidden fixing finish.

The Guide lays over the decking board and is suitable for board widths of 145-200mm, making it compatible with all Millboard decking boards, and even some softwood decking boards. When used in combination with Durafix® screws and the complimentary driver bit, the Guide aligns the screws perfectly and controls the fixing depth, too.

The DuoFix Side-Fixing Guide provides a 6mm spacing between boards.

Discover more about fixings and accessories:
millboard.co.uk/subframe-accessories

Step 1

No countersinking or pre-drilling required, drive the Durafix® straight in

Step 2

Sink so that the Durafix® head lies approximately 5mm below the surface

Step 3

The Lastane® surface is pliable, leaving a small witness mark

Working Specification & Installation Tips

Decking Boards

For all applications we recommend a 4mm space between the sides of boards (or 6mm if using the DuoFix side-fixing guide) and 1mm gap at the ends on butt joints. A 10mm gap should be left between the boards and any abutting vertical surface to facilitate drainage. The maximum unsupported overhang for the boards is 50mm and each cut board must be supported by a minimum of three joists. Where a board crosses a joist, two Durafix® fixings will be needed. At the end of the boards, we'd recommend three Durafix® fixings.

| Type | Uniform Distributed Load |
|--------------------------|---------------------------|
| Commercial applications | $\leq 5 \text{ kN/m}^2$ |
| Residential applications | $\leq 2.5 \text{ kN/m}^2$ |

Commercial applications

Joists must support boards at 300mm centres if boards are at 90° to joists. If boards are at 45° then joists need to be set at 240mm centres.

Residential applications

Joists must support boards at 400mm centres if boards are at 90° to joists. If boards are at 45° then joists need to be set at 300mm centres.

View the Installation Guide and more:
millboard.co.uk/downloadable-guides

Board and Joist Spacing

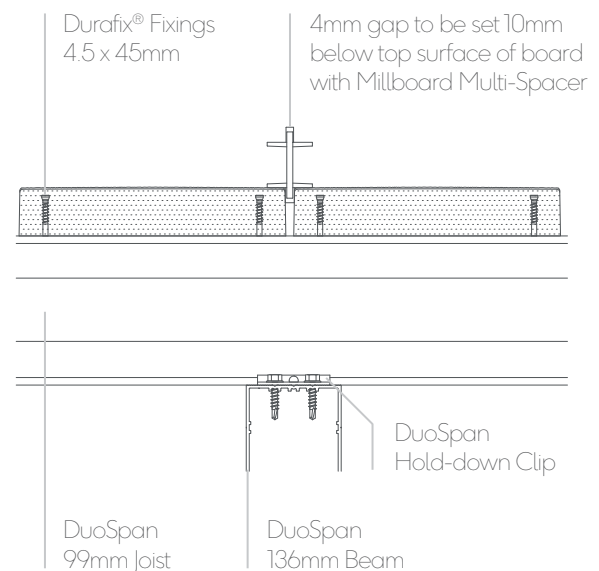
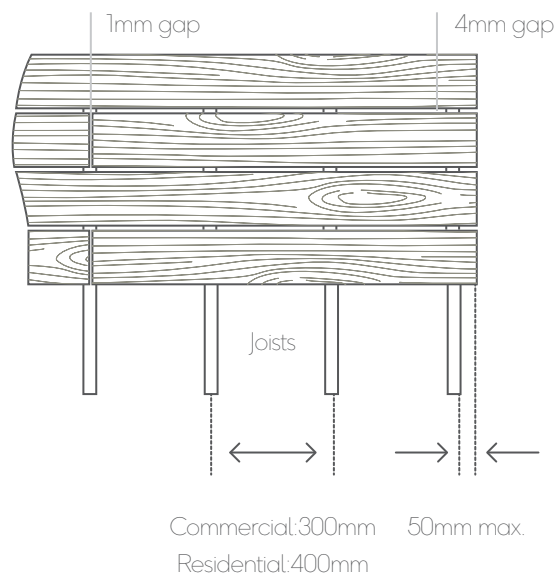

Full installation instructions and videos:
millboard.co.uk/how-to-videos

Full CAD drawings available at:
millboard.co.uk/architect-resources

Working Specification & Installation Tips

Edging & Fascia

Millboard edging trims must be supported along their length by a support around the perimeter. Millboard edging trims/fascias must be fixed at 300mm centres along their length, using the Durafix fixings.

| Type | Dimensions | Bend radius |
|--------------------------|-------------------|---------------|
| Square Edging | 50 x 32 x 3200mm | 3m |
| Flexible Bullnose Edging | 50 x 32 x 2400mm | 1.2m |
| Fascia Board | 146 x 16 x 3200mm | 1.2m |
| Bullnose Board | 150 x 32 x 3200mm | Does not bend |

View the Installation Guide and more:
millboard.co.uk/downloadable-guides

Colour options

The edge trims are available in nine colours, which can be used to match the decking boards, as a design contrast or to assist partially sighted persons, which is a requirement for some public applications.

Dimensional stability

There will always be a slight variance in the board's dimensions due to the fact that we mould from natural oak, and due to the pressure of the moulding process. Despite this, we calibrate the boards to maintain as consistent a profile as possible. The manufacturing tolerances are: Width: ± 3mm. Length: ± 5mm. Thickness: ± 2mm.

As the boards are made from a resin mineral composition it is stable in comparison to timber or composites based on timber, the amount of movement that is acceptable is up to 0.2%.

Installing Edging & Fascia

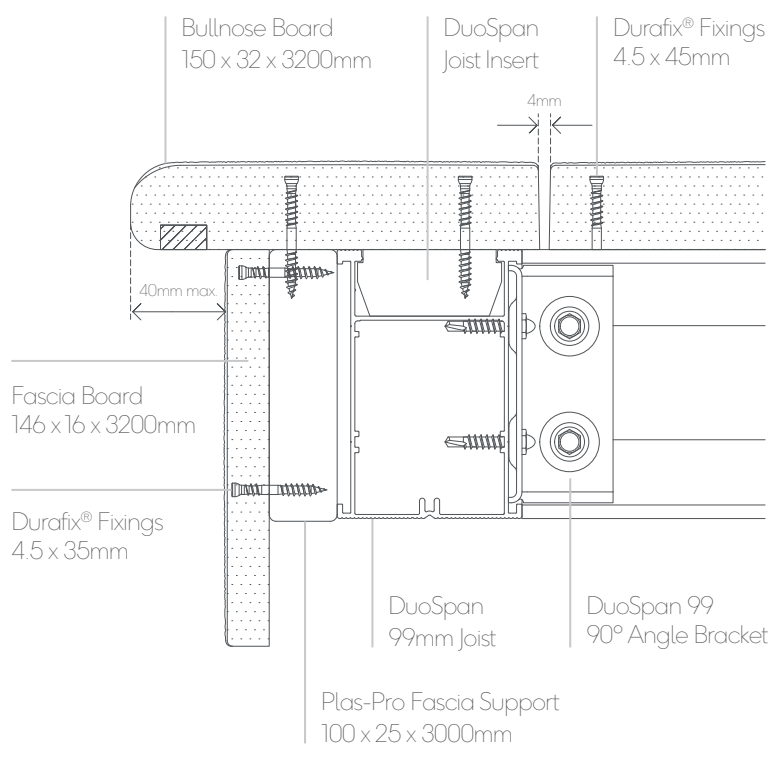

/// Max. recess area for LED strip lighting is 17 x 9mm, up to 11mm from the fascia.

Technical data for all products:
millboard.co.uk/technical-specifications

Creating a curved edge

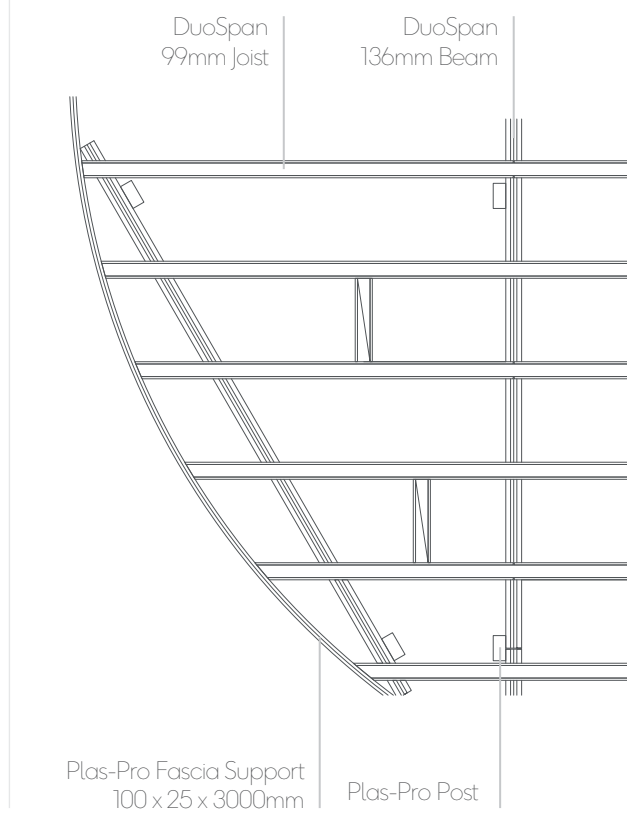

Pursuing a sustainable path

Life. Living. Livelihood.

We believe in the beauty of life in its many forms. Ensuring a sustainable future is intrinsic to our nature. Our approach to sustainability is simple. Every day, we consider the impact that our actions will have on the future of life, living and livelihoods, and strive to make choices that are fair and considerate.

At our heart, we're lovers of outdoors and the life that can be enjoyed outside. We want everyone to enjoy life in that way, and we want to ensure that future generations can as well.

We know that we can't work miracles, but we believe in the power of one right choice after another. Many small steps create a sustainable path.

Our initiative is broken down into three main sections Life, Living and Livelihood. Each topic includes five commitments that detail how we have pledged towards the future of life, living and livelihoods so that we, and generations beyond us, can all continue to Live Life Outside.

Read more about our approach, and join us on our quest to enhance the quality of life, living and livelihoods for all. Visit our website at www.millboard.co.uk/sustainability.

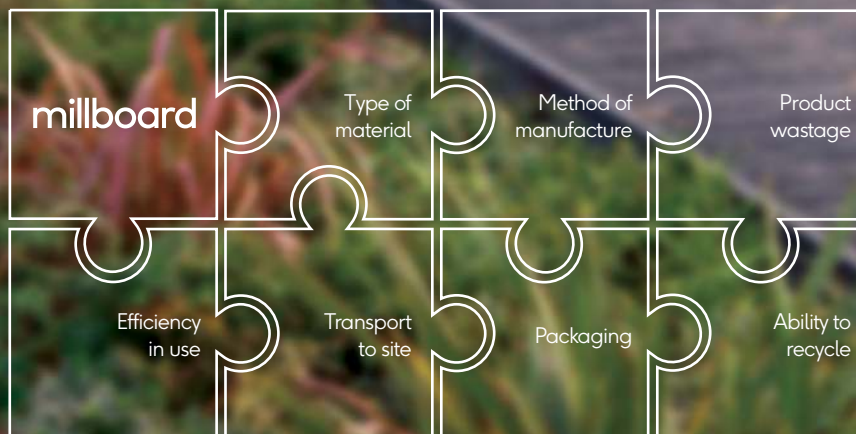

Low Carbon Footprint
1.31kg CO₂/M² to ISO14064.



Recycled Fillers
Made using recycled minerals.



Biopolymers
Made using renewable biopolymers.

Maintenance

Millboard decking achieves superior outdoor spaces. Our boards perfectly mimic the beauty of natural wood and provide a practical, low-maintenance surface, which only requires cleaning occasionally – leaving you free to simply enjoy life outdoors.

Our innovative decking gives you the assurance of high slip-resistance and zero chance of rotting without the need for intensive maintenance. A simple wash clean is all it needs.

Here are a few simple maintenance tips:

- Remove spills and marks with plenty of water, a mild detergent and a cloth or brush (no solvents, chemicals or abrasive cleaners are generally needed). Strong dyes and stains that fall on your decking, such as berries and animal droppings, should not be left. Remove these as soon as possible to prevent marking.
- Stubborn marks may be removed with a range of different cleaners depending on the mark. Please contact us for more information.
- Take care when moving sharp objects across your decking to avoid marking, e.g. unprotected table or chair legs, spiked shoes or metal planter bases.
- Use a small amount of granulated white salt (not rock salt) to tackle ice in the winter, and simply wash it off with soapy water and a brush once the weather warms up.
- Clean your decking twice a year or as required, dependant on location and usage, to remove leaves and general dirt particles; this can be done with warm, soapy water and a brush.

If you have any queries or concerns regarding your Millboard decking, please email us at enquiries@millboard.co.uk, or call our UK support team on **024 7643 9943**.



Alternative Uses

Landscapers and gardeners everywhere are discovering that Millboard decking's versatility and durability makes it very suitable for seating arrangements, planters, gates and eating areas.

As Millboard decking can be mitred and glued using PU wood adhesive, it makes it very easy to create a seamless masterpiece.





Millboard products have previously been used in a variety of ways including:

- Bridges
- Feature walls
- Residential cladding
- Gates
- Planters
- Pond surrounds
- Pool surrounds
- Seating
- Table-tops
- Tree houses

All areas subject to government regulations/building control

Find inspiration for your next project at:

millboard.co.uk/design-inspiration



Above: Dovetail Timber Homes

Credit: SHH Architects / MY Construction

Coming soon!

Millboard Envello® Cladding

Coming soon: Millboard Envello Cladding. Inspired by the beauty of nature but built to outperform it, like our decking boards the Millboard Envello Cladding range is moulded from selected timbers making it look exceptionally like real wood, whilst avoiding the on-going maintenance associated with natural or wood based products.

The hand colouring of each board recreates the subtle nuances that only natural wood can give. The moulded profiles reduce labour and wastage yet retain the effect of individual boards.





Select your Millboard decking

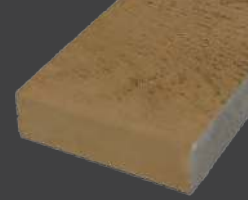

Enhanced Grain

Weathered Oak

176 x 3600 x 32mm

200 x 3600 x 32mm

Antique Oak
Page 10

MDE176A

—

Smoked Oak
Page 12

MDE176D

—

Brushed Basalt
Page 14

MDE176B

—

Limed Oak
Page 16

MDE176L

—

Burnt Cedar
Page 18

MDE176R

—

Golden Oak
Page 20

MDE176G

—

Coppered Oak
Page 22

MDE176C

—

Jarrah
Page 24

MDE176J

—

Vintage
Page 36

—

MDW200V

Driftwood
Page 38

—

MDW200D

Embered
Page 40

—

MDW200R

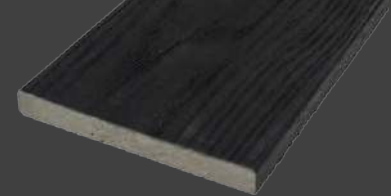
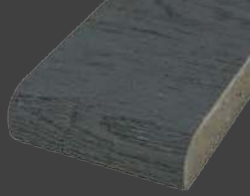
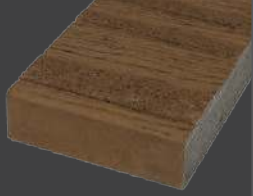

Lasta-Grip

200 x 3600 x 32mm

Bullnose Board

150 x 3200 x 32mm

Flexible Bullnose Edging

50 x 2400 x 32mm

Square Edging

50 x 3200 x 32mm

Fascia Board

146 x 3200 x 16mm

| | | | | |
|---------|----------|---------|---------|---------|
| — | MEBB150A | MEBF50A | MEUN32A | MFN320A |
| — | MEBB150D | MEBF50D | MEUN32D | MFN320D |
| — | MEBB150B | MEBF50B | MEUN32B | MFN320B |
| — | MEBB150L | MEBF50L | MEUN32L | MFN320L |
| — | MEBB150R | MEBF50R | MEUN32R | MFN320R |
| MDL200G | MEBB150G | MEBF50G | MEUN32G | MFN320G |
| MDL200C | MEBB150C | MEBF50C | MEUN32C | MFN320C |
| — | MEBB150J | MEBF50J | MEUN32J | MFN320J |
| — | MEBB150V | MEBF50V | MEUN32V | MFN320V |
| — | MEBB150D | MEBF50D | MEUN32D | MFN320D |
| — | MEBB150R | MEBF50R | MEUN32R | MFN320R |

These swatches are representative only; due to the replications of natural hardwood, the complete deck may have slight variations in colour tone and graining.

Ordering samples

Choosing your Millboard deck is a significant decision and one that you will want to get right. We make it easy to confirm your choice, with appointed distributors across the UK holding stocks of the Millboard range available for you to view.

Nothing beats seeing and walking on a Millboard deck for real, but we're happy to send you some free samples so that you can experience the unique colours and grain textures up close.

Order a free sample pack: millboard.co.uk/samples



Millboard showrooms

Visit one of our selected showrooms to experience the true beauty of Millboard decking and cladding and see the endless design possibilities that you can achieve with Millboard products.

Each showroom includes striking displays of the many creative ways in which Millboard can be used – both innovative laying styles and alternative uses in creating steps, planters, water features and more.

Find your nearest showroom: millboard.co.uk/showrooms



Ordering and installation

Purchasing your Millboard deck is simple. Appointed stocking distributors across the UK and beyond are available to assist you and to help you to fulfil your requirements. Should you have any difficulty locating a distributor in your area, please contact our team who will gladly direct you. Where assistance is required on planning larger projects, our technical team can provide in-depth support with both design and practical considerations.

Millboard decking is straightforward to install. However, we'd recommend using an experienced contractor – our list of trained and approved installers covers most areas of the UK.

Find an Approved Installer or stockist: millboard.co.uk/locator





The finest outdoors

millboard

millboard.co.uk

The Millboard Company Ltd
UK Head Office
Castle Court
Bodmin Road
Coventry CV2 5DB

T +44 (0) 24 7643 9943
F +44 (0) 24 7661 1668
E enquiries@millboard.co.uk

Company registered No. 06061318
VAT No: 980 616602
Brochure edition: 2021 V1.2



© 2021 The Millboard Company Ltd. Millboard®, Lastane®, Durafix®, Lasta-Grip®, DuoSpan®, DuoLift® and the phrase "Live Life Outside™" are protected trademarks. Patents and Patents Pending apply to Millboard® products. The company will vigorously defend its patent rights. Due to printing restraints, actual colours may vary from those shown in brochure. This brochure is not to be reproduced or copied without written permission from Millboard directors. Millboard has a policy of continual improvement to specification. Product blend, colours and sizes may change without notice. All sizes and measurements are nominal. Information is correct at time of going to press.

Patent numbers include GB 2445714, GB 2449184, USA 8,065,849, CAN 2664329, EU 1951971.

